











LTW75 7,5 t | LTW85 8,5 t | LTW100 10 t



-  Sollevatore a colonne mobili
-  Mobile columns
-  Fahrbare Radgreifer-Hebeböcke
-  Elévateur à colonnes mobiles
-  Elevador de columnas móviles



-  Sollevamento elettromeccanico mediante sistema vite-chiocciola • Chiocciola portante in ZELLAMID e di sicurezza in acciaio • Centrale di comando con sistema PLC • Auto-livellamento elettronico delle colonne • Unità di comando montata a bordo colonna (opzionale carrellata) • Pulsanti salita/discesa su tutte le colonne • Pulsante di arresto di emergenza su tutte le colonne
-  Electromechanical system with spindle-nut-assy • ZELLAMID bearing nut and steel safety nut • PLC-control unit • Electronic alignment control • Control unit on main post (separate control cabinet on trolley as option) • Up / Down button on each column • Emergency stop on all posts
-  Elektromechanisches Hubsystem mit Spindel und Hubmutter • ZELLAMID-Tragmutter und Stahl-Sicherheitsmutter • Speicher Programmierbare Steuerung (SPS) • Elektronische Gleichlaufüberwachung • Haupt-Steuerkasten an Säule montiert (Getrennter, mobiler Steuerkasten auf Wunsch lieferbar) • Auf-/Ab-Knopf an jeder Säule • Not-Aus-Piltzaste an jeder Säule
-  Système électromécanique avec vis de commande et écrou porteur • Ecrou en ZELLAMID et écrou de sécurité en acier • Commandes avec automates programmables • Système électronique de contrôle de l'alignement • Unité de commande sur colonne principale (pupitre de contrôle mobile disponible sur demande) • Bouton de montée/déscente sur chaque colonne
-  Elevación electro-mecánica mediante sistema tornillo-caracol • Caracol portante en ZELLAMID y de seguridad en acero • Central de mandos con sistema PLC • Auto-nivelación electrónica de las columnas • Unidad de mandos montada en columna (en opción sobre carrito) • Botones de elevación/descenso en todas las columnas • Botón de parada de emergencia en todas las columnas.

LTW75 7,5 t | LTW85 8,5 t | LTW100 10 t



SAFETY FIRST







SLAVE



HIGH MODULARITY



-  Elevata modularità e flessibilità: 2-4-6-8 colonne
-  High modularity and flexibility: 2-4-6-8 columns
-  Hohe Modularität und Flexibilität: 2-4-6-8 Böcke
-  Haute modularité et flexibilité: 2-4-6-8 colonnes
-  Alta modularidad y flexibilidad: 2-4-6-8 columnas

LTW75 7,5 t | LTW85 8,5 t | LTW100 10 t



Pulsante di arresto di emergenza su tutte le colonne
Emergency stop on all posts of the kit
Not-Aus-Piltzaste an jeder Säule
Arrêt d'urgence sur chaque colonne
Botón de parada de emergencia en todas las columnas



Timone di manovra
Steering drawbar
Lenkdeichsel
Timon de manoeuvre
Barra de maniobra



Chiocciola portante in ZELLAMID
ZELLAMID main nut
Tragmutter aus ZELLAMID
Ecrou porteur en ZELLAMID
Tuerca principal en ZELLAMID

LTW75 7,5 t | LTW85 8,5 t | LTW100 10 t



LTW75/LTW85

LTW100

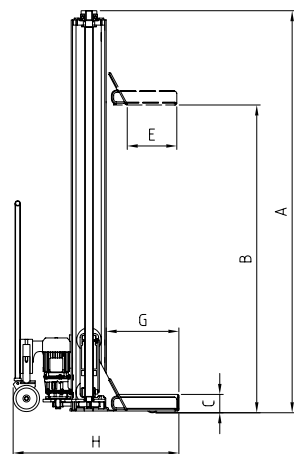
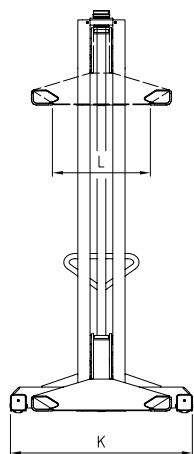

	LTW75	LTW85	LTW100
A	2359	2359	2469
B	1750	1750	1750
C	105	105	105
E	302	302	323
G	477	477	511
H	1110	1110	1068
K	1040	1040	1200
L	560	560	594

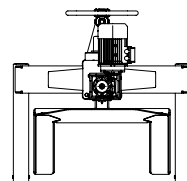
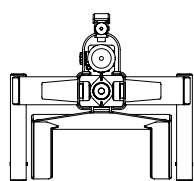
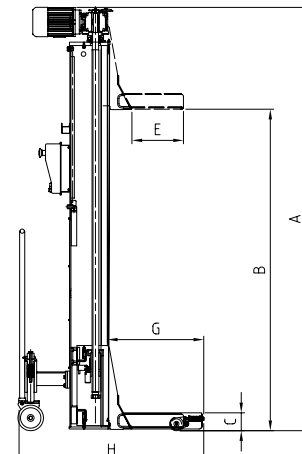
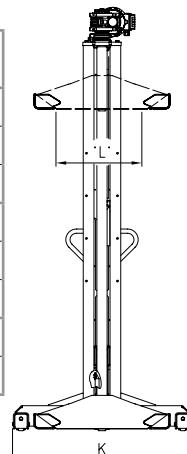

Dati tecnici	Technical data	Technische Eigenschaften	Caractéristiques techniques	Datos técnicos	LTW75	LTW85	LTW100
Capacità massima	Max. Load Capacity	Tragfähigkeit	Capacité max	Capacidad máx. de carga	7,5 t	8,5 t	10 t
Corsa	Stroke	Hub	Course	Carrera	1750 mm		
Tempo di sollevamento	Lifting time	Hubzeit	Temps de levage	Tiempo de elevación	220 s	220 s	250 s
Dimensione pneumatico	Tyre dimensions	Reifenabmessungen	Dimensions des pneus	Medida del neumático	900-1200 mm	900-1200 mm	1000-1300 mm
Voltaggio	Voltage	Spannung	Voltage	Voltaje	230-400V/50 Hz/3 ph		
Potenza elettrica	Electrical power	Motorleistung	Puissance électrique	Potencia eléctrica	1,85 kW	1,85 kW	3,0 kW
Lunghezza cavi di collegamento colonne	Connecting column cable length	Länge del Kabel zwischen den Säulen	Longueur des câbles entre colonnes	Longitud cables de conexión de columnas	12 m		
Grado di protezione IP (esecuzione STD)	Index of protection IP (STD execution)	Isolationsklasse IP (STD Ausführung)	Indice de protection IP (exécution STD)	Índice de protección IP (ejecución STD)	IP54		
Peso	Weight	Gewicht	Poids	Peso	320 kg	320 kg	440 kg
Sincronizzazione elettronica	Electronic synchronisation	Elektronischer Ausgleich	Synchronisation électronique	Sincronización electrónica		✓	
Sensore ostacolo sottoforca	Safety device under fork obstacle	Sensor bei Hindemis	Détecteur d'obstacle	Sensoar obstáculo debajo de horquilla		✓	
Comandi "uomo presente"	"Dead man" control push buttons	Totmannschaltung	Contacteur «Homme-mort»	Mandos de «Hombre presente»		✓	
Fincorsa	End-Stroke	Endschalter	Fin de course haut de bas	Final de carrera		✓	
Timone di manovra	Steering drawbar	Lenkdeichsel	Timon de manoeuvre	Barra de maniobra		✓	



Opzioni	Optionals	Sonderzubehör	Options	Opcionales
Unità di comando carrellata	Separate control unit on trolley	Getrennter, mobiler Steuerkasten	Pupitre de commande mobile	Unidad de mandos sobre carrito
Set riduzioni forche	Set of fork reduction for smal wheels	Gabelreduktion	Réducteur de fourches	Juego de reducciones de las horquillas
Traversa libera ruote, portata 15 tons	15 ton wheels free cross beam	15 ton Radfreiheber-Quertraverse	Traverse amovible 15 ton	Travesaño libera ruedas, capacidad 15 t
Prolunghe per collegamento tra le colonne	Connection cable extensions	Kabelverlängerungen von Säule zu Säule	Rallonge des câbles entre colonnes (standard 12 m)	Prolongación de cables de conexión entre columnas
Cavalletti di sostegno, portata 7,5 e 10 ton	7,5 and 10 ton axle stand	Unterstellböcke, Tragkraft 7,5 und 10 Tonnen	Chandelles, capacité 7,5 et 10 tonnes	Caballetes de sostén, capacidad 7,5 y 10 t
Esecuzione per esterni con grado di protezione IP65	Outdoor installtion with index of protection IP65	usführung für Installation im Freien mit Schutzindex IP65	Exécution pour installation à l'extérieur avec indice de protection IP65	Construcción para uso al aire libre con índice de protección IP 65