











450AT 4,0 t



-  Sollevatore elettroidraulico a 4 colonne con incavi anteriori e piastre oscillanti posteriori per allineamento ruote
-  Electro-hydraulic 4 post lift with front recesses and rear slipping plates for wheel alignment
-  Elektrohydraulische 4-Säulen-Hebebühne mit vorderen Aussparungen und hinteren Schiebepplatten für die Achsvermessung
-  Pont élévateur électro-hydraulique à 4 colonnes avec encastres avant et plaques arrière pour géométrie
-  Elevador electro-hidráulico de 4 columnas con asientos delanteros y platos oscilantes traseros para alineación de las ruedas



-  Sicurezza idraulica contro il sovraccarico • Valvola regolazione discesa • Segnale acustico ultimo tratto di discesa • Sicurezza idraulica in caso di rottura tubi idraulici • Comandi uomo presente 24 V • Sgancio elettrico del sistema di sicurezza meccanico
-  Overload safety valve • Descent control valve • «Buzzer» on last portion of descent • Pipe burst safety valve • 24 V, low tension dead man controls • Automatic release of safety locking devices
-  Überdruckventil gegen Überlastung • Senksteuerventil • Akustisches Signal im letzten Teil der Senkbewegung • Rohrbruchsicherung • 24 V-Totmann-Steuerung • Elektrische Entriegelung der mechanischen Lastsicherung
-  Vanne de surpression contre surcharges • Vanne de réglage descente • Signal sonore sur la dernière partie de descente • Vanne d'arrêt en cas de rupture de la tuyauterie • Commandes de type homme mort à 24 V • Déverrouillage électrique du système de sécurité mécanique
-  Seguridad hidráulica contra la sobrecarga • Válvula de regulación del descenso • Señal acústica último tramo de descenso • Seguridad hidráulica en caso de rotura tubos hidráulicos • Mandos de hombre presente, 24V • Desenganche eléctrico del sistema de seguridad mecánico

450AT 4,0 t

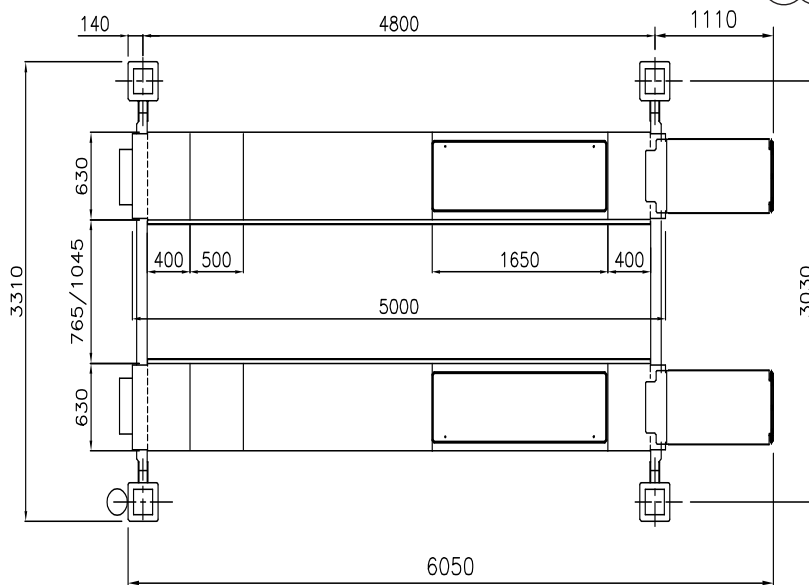
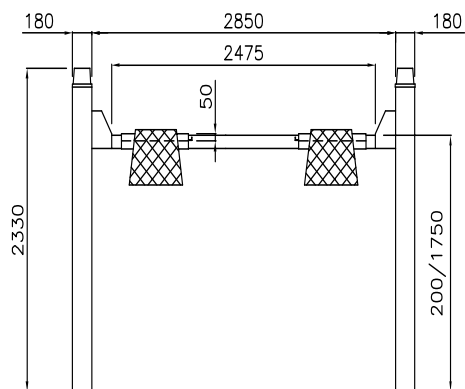

Dati tecnici	Technical data	Technische Eigenschaften	Caractéristiques techniques	Datos técnicos	
Funzionamento: Elettroidraulico	Operation: Electro-hydraulic	Funktionsweise: Elektrohydraulisch	Fonctionnement: Electrohydraulique	Funcionamiento: Electro-hidráulico	
Portata	Capacity	Tragfähigkeit	Capacité	Capacidad	4.000 kg
Peso	Weight	Gewicht	Poids	Peso	1300 kg
Salita/Discesa	Lifting/lowering	Hub/Senkzeit	Levage/descente	Subida/bajada	50 / 45 s
Altezza di sollevamento	Lifting height	Hubhöhe	Hauteur de levage	Altura de elevación	1750 mm
Motore	Motor	Motorleistung	Puissance moteur	Motor	2,2 kW - 3 ph 230 400V/50 Hz



Opzioni	Optionals	Sonderzubehör	Options	Opcionales
---------	-----------	---------------	---------	------------



Traversa idraulica ausiliaria (vedere scheda specifica)
Hydraulic jacking beam (see relevant data sheet)
 Hydraulischer Rad-freiheber (s. eigenes Datenblatt)
 Levage auxiliaire hydraulique (voir fiche technique)
 Elevador hidráulico auxiliar (ver ficha técnica)

Esecuzione con motore monofase
Single-phase motor
 Ausführung mit Einphasenmotor
 Moteur monophasé
 Motor monofásico

Kit illuminazione
Illumination kit
 Beleuchtungsset
 Kit d'éclairage
 Kit de iluminación

Carter protezione centralina
Cover for control unit
 Abdeckung für Hydraulikaggregat
 Carter protection centrale hydraulique
 Cubierta protectora para la centralita

Disponibili versioni corrispondenti a normative specifiche (M.O.T.)
Available with specific M.O.T. norms upon request
 Es sind Ausführungen nach spezifischen Normen lieferbar (M.O.T.)
 On peut livrer versions correspondantes à normes spécifiques (M.O.T.)
 Disponibles versiones correspondientes a normas específicas (M.O.T.)

Coperchi per incavi anteriori
Covers for front recesses
 Abdeckbleche für Frontaussparungen
 Complements pour encastresments avant
 Tapa para asientos delanteros



Piatti Rotanti
Radius plates
 Drehplatten
 Plaquas pivotantes
 Platos giratorios