











# 450-3DB 5,0 t



-  Sollevatore elettroidraulico a 4 colonne alta velocità con incavi anteriori, piastre oscillanti posteriori e pedane strette per assetto ruote 3D
-  Electro-hydraulic high speed 4 post-lift with front recesses, rear slipping plates and narrow platforms for 3D-wheel alignment
-  Elektrohydraulische 4-Säulen Hebebühne mit vorderen Aussparungen, hinteren Schiebepplatten und hoher Hubgeschwindigkeit, schmale Fahrschienen für 3D-Achsvermessung
-  Pont élévateur Electrohydraulique 4 colonnes grande vitesse avec encastrés avant, plaques arrière et chemins de roulement étroits pour contrôle train avant 3D
-  Elevador electro-hidráulico de 4 columnas alta velocidad con asientos delanteros, platos oscilantes traseros y plataformas estrechas para alineación 3D de las ruedas



-  Sicurezza in caso di rottura fune • Sicurezza idraulica contro il sovraccarico • Valvola regolazione discesa • Sicurezza idraulica in caso di rottura tubi idraulici • Comandi uomo presente 24 V • Sgancio automatico delle sicurezze per la discesa • Insonorizzazione sicurezze • Valvola manuale controllo discesa • Massima altezza pedane 1970mm • Segnale acustico ultimo tratto di discesa • Piastre oscillanti posteriori con bloccaggio pneumatico
-  Safety device in case of rope breaking • Overload safety valve • Descent control valve • Pipe burst safety valve • 24 V dead man controls • Automatic disengagement of the safety wedges prior to descent • Sound dampening of safety locks • Manual descent valve • Max. lifting height of platforms 1970mm • 'Buzzer' on last portion of descent • Rear slipping plates with pneumatic locking
-  Seilbruchsicherung • Überdruckventil gegen Überlastung • Senksteuerventil • Rohrbruchsicherung • 24 V-Totmann-Steuerung • Automatische Entriegelung der Lastsicherungshebel vor dem Absenken • Schalldämpfung der Lastsicherungshebel • Manuelles Senkventil • Max. Höhe der Fahrschienen 1970 mm • Akustisches Signal im letzten Teil der Senkbewegung • Hinteren Schiebepplatten mit pneumatischer Verriegelung
-  Sécurité en cas de rupture du câble • Vanne de surpression contre surcharges • Vanne de réglage descente • Vanne d'arrêt en cas de rupture de la tuyauterie • Commandes de type homme mort à 24 V • Déclenchement automatique des crochets • Insonorisation des sécurités mécaniques • Vanne manuelle de descente • Hauteur max. des chemins de roulement 1970 mm • Signal sonore sur la dernière partie de descente • Plaques arrière avec blocage pneumatique
-  Seguridad en caso de rotura del cable de acero • Seguridad hidráulica contra la sobrecarga • Válvula de regulación descenso • Seguridad hidráulica en caso de rotura de tubos hidráulicos • Mandos de hombre presente, 24V • Desenganche automático de las seguridades para el descenso • Insonorización seguridades • Válvula manual de control del descenso • Altura máxima plataformas 1970mm • Señal acústica último tramo de descenso • Platos oscilantes traseros con bloqueo neumático

# 450-3DB 5,0 t

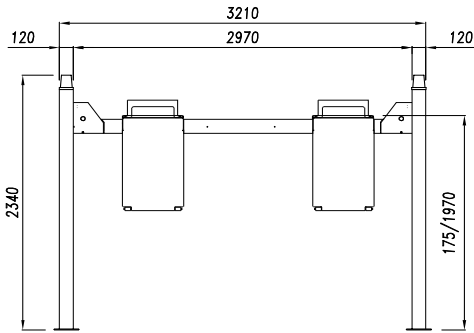
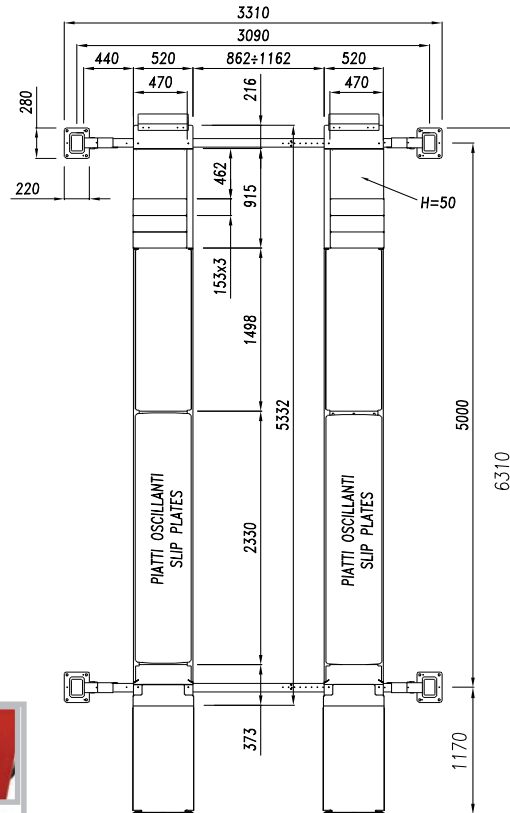

Dati tecnici	Technical data	Technische Eigenschaften	Caractéristiques techniques	Datos técnicos	
Funzionamento: Elettroidraulico	Operation: Electro-hydraulic	Funktionsweise: Elektrohydraulisch	Fonctionnement: Electrohydraulique	Funcionamiento: Electro-hidráulico	
Portata	Capacity	Tragfähigkeit	Capacité	Capacidad	5.000 kg
Peso	Weight	Gewicht	Poids	Peso	1230 kg
Salita/Discesa	Lifting/lowering	Hub/Senkzeit	Levage/descente	Subida/bajada	35 / 35 s
Altezza di sollevamento	Lifting height	Hubhöhe	Hauteur de levage	Altura de elevación	1970 mm
Motore	Motor	Motorleistung	Puissance moteur	Motor	3 kW - 3 ph 230 400V/50 Hz



Opzioni	Optionals	Sonderzubehör	Options	Opcionales
---------	-----------	---------------	---------	------------



.9B

Traversa idraulica ausiliaria (vedere scheda specifica)  
 Hydraulic jacking beam (see relevant data sheet)  
 Hydraulischer Radfreiheber (s. eigenes Datenblatt)  
 Levage auxiliaire hydraulique (voir fiche technique)  
 Elevador hidráulico auxiliar (ver ficha técnica)



Piatti Rotanti  
 Radius plates  
 Drehplatten  
 Plaques pivotantes  
 Platos giratorios