





# 280A 2,8 t



-  Sollevatore asimmetrico con trasmissione a catena
-  Electro-mechanical asymmetric lift with chain drive
-  Elektromechanische, asymmetrische Hebebühne mit Kettenantrieb
-  Elévateur électro-mécanique asymétrique avec transmission par chaîne
-  Elevador electro-mecánico asimétrico con transmisión por cadena



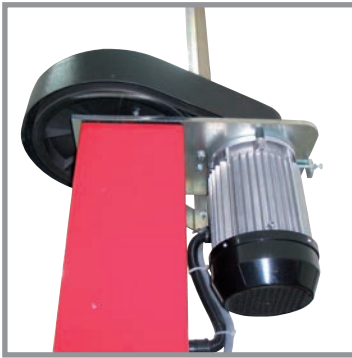

Motore speciale ad alto rendimento per garantire potenza e durata nel tempo, dotato di sonda termica di protezione

Specially manufactured motor fitted with overheating & overload protection switch

Spezieller Hochleistungsmotor mit Thermoschutz liefert üppig bemessene Antriebsleistung und gewährleistet lange Lebensdauer

Moteur spécial à haute performance pour garantir puissance et durée dans le temps, équipé de sonde thermique de protection

Motor especial de alto rendimiento para garantizar potencia y duración en el tiempo, suministrado con termico de protección

Vite rullata in acciaio ad alta resistenza per garantire la massima durata nel tempo

Steel high resistance rolled screw to provide long life

Kaltgewaltze Spindel aus gehärtetem Stahl für eine lange Lebensdauer

Vis en acier, roulée, à haute résistance, pour garantir la durée dans le temps

Husillo de acero de alta resistencia, rosca fabricada en frío con rodillos para garantizar la máxima duración en el tiempo







Chiocciola portante in Nylatron GSM ad elevata resistenza all'usura a garanzia di sicurezza totale

Nylatron GSM main nut with high resistance to wear for greater safety

Verschleissfeste Tragmutter aus Nylatron GSM für eine totale Sicherheit

Ecrou porteur en Nylatron GSM à haute résistance à l'usure pour garantir une sécurité totale

Tuerca principal en Nylatron GSM de alta resistencia al desgaste para garantizar la seguridad total

-  Ponte con pedana per un più agevole montaggio su pavimenti di scarsa qualità • Altezza minima tamponi di soli 90 mm. Bracci corti e lunghi a tre stadi per facilitare il caricamento asimmetrico di veicoli larghi e più lunghi in posizione estesa: raccomandati per il sollevamento di fuoristrada • Trasmissione con catena ad alta resistenza, prestirata, con dispositivo di sicurezza di controllo d'allentamento • Lubrificazione permanente e automatica della vite • Motore speciale ad alto rendimento per garantire potenza e durata nel tempo, dotato di sonda termica di protezione • Funzionamento: elettromeccanico
-  Lift with self supporting baseframe for easier installation on poor quality floor surfaces • Pads with a min.height of 90 mm. only. Three stage short and long arms enabling the asymmetric loading of wide and longer vehicles: recommended for the lifting of off-road vehicles • High resistance chain transmission, pre-stretched, with control safety device upon loosening • Permanent and automatic screw lubrication • Specially manufactured high performing motor fitted with overheating & overload protection switch • Operation: electro-mechanical
-  Grundrahmenbühne für Befestigung auf instabile oder nicht tragfähige Böden • Mindesthöhe der Aufnahmepunkte ist nur 90 mm. Dreifach teleskopische lange und kurze Arme um die problemlose asymmetrische Aufnahme breiter und langer Fahrzeuge bei voll ausgezogenen Teleskoparmen zu gewährleisten: besonders empfohlen zum Heben von 'Off-Road'-Fahrzeugen • Kettenantrieb mit vorgespannter Hochleistungskette. Kettenbruch- und Kettenschlaffungs-Überwachung • Automatische Permanentschmierung der Spindel • Spezieller Hochleistungsmotor mit Thermoschutz liefert üppig bemessene Antriebsleistung und gewährleistet lange Le
-  Pont à base porteuse pour un montage plus facile sur les sols de basse qualité • Hauteur min. tampons de 90 mm seulement. Bras courts et longs en trois parties pour faciliter le chargement asymétrique de véhicules larges et plus longs: recommandés pour le evage de tout-terrains • Transmission à chaîne à haute résistance, pré-étirée avec dispositif de sécurité de contrôle desserrage • Lubrification constante et automatique de la vis • Moteur spécial à haute performance pour garantir puissance et durée dans le temps, équipé de sonde thermique de protection • Fonctionnement: électro-mécanique
-  Elevador con base para facilitar la instalación en suelos de baja calidad • Altura máxima tampones sólo 90 mm. Brazos largos y cortos de tres fases para facilitar la carga de vehículos más anchos y más largos cuando está en posición completamente extendida: recomendado para los vehículos off-road • La transmisión por cadena, con control del dispositivo de seguridad de aflojamiento • Lubricación permanente y automática de los tornillos • Motor especial de alto rendimiento para garantizar potencia y duración en el tiempo, suministrado con termico de protección • Funcionamiento: electro-mecánico

# 280A 2,8 t



Arresto bracci a inserimento automatico e sgancio automatico a terra

Automatic locking & unlocking of arms on floor

Schwenkarmarretierung rastet automatisch ein (in der unteren Nullstellung) und aus (beim Heben aus der Nullstellung)

Arrêt des bras à insertion automatique et désinsertion automatique à terre

Parada de brazos de activación automática y desenganche automático de tierra

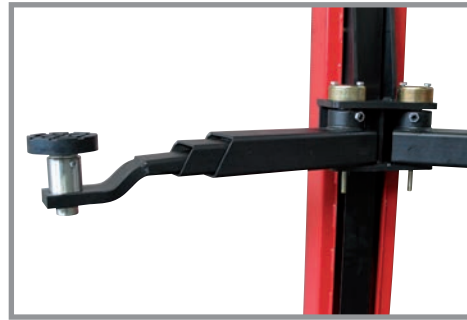

Comando a uomo presente, 24V

Dead man controls, 24V

24V - Totman-Schaltung

Commande "homme mort", 24V

Mandos de hombre presente, 24V

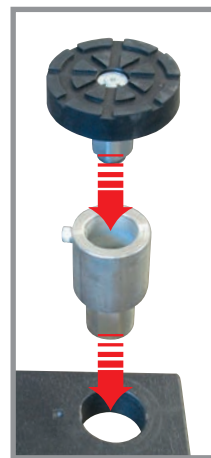

Bracci predisposti per l'alloggiamento rapido di prolunghe

Arms suitable for quick drop-in extensions

Aufnahmen mit Schnellstecksystem erleichtern den Einsatz von Verlängerungen.

Bras prévus pour le montage rapide de rallonges

Brazos dispuestos para el alojamiento rápido de suplementos.



Opzioni



Optionals



Sonderzubehör



Options



Opcionales

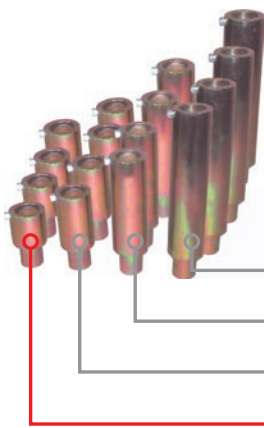

Estensioni per tamponi (kit 4 pz)

Lifting pad extensions (4 pcs set)

Hubspindelverlängerungen (Satz 4 Stk)

Rallonges pour tampons (jeu de 4 pcs)

Extensiones para tacos (kit 4 un.)

250 mm (L955)

170 mm (L954)

100 mm (L953)

60 mm (L956 standard included)



Kit energy: supporto attrezzi e prese aria e corrente

Kit energy: tool support, air connection and electric power plug

Kit Energy: Werkzeughalter, Luftanschluss und Steckdose

Kit énergie: support outils, prises d'air et de courant

Kit energy: soporte herramientas y conexiones de aire y de corriente

# 280A 2,8 t

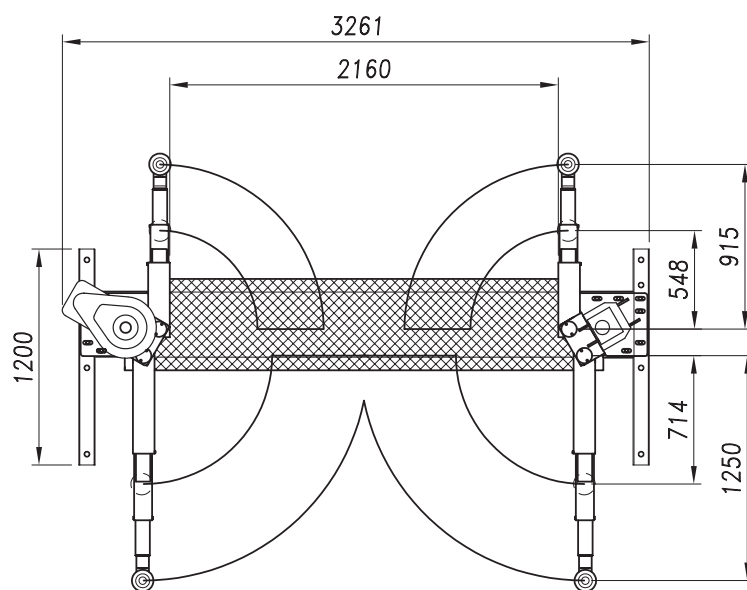
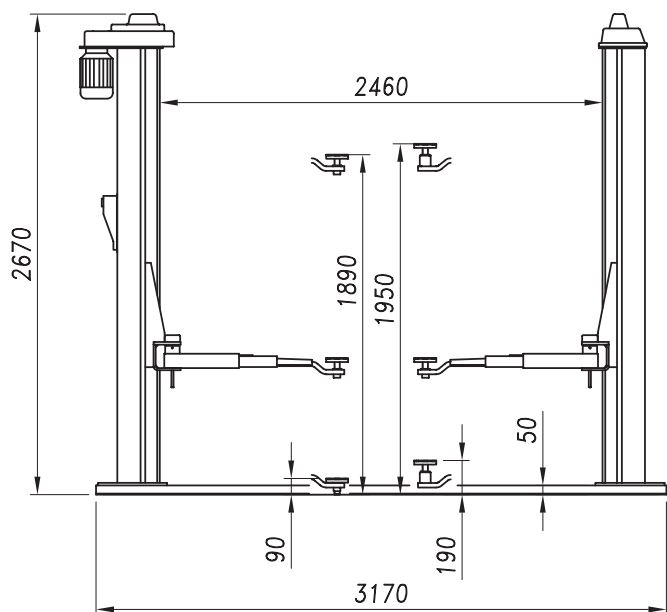

Dati tecnici	Technical data	Technische Eigenschaften	Caractéristiques techniques	Datos técnicos	
Portata	Capacity	Tragfähigkeit	Capacité	Capacidad	2.800 kg
Peso	Weight	Gewicht	Poids	Peso	620 kg
Salita/Discesa	Lifting/lowering	Hub/Senkzeit	Levage/descente	Subida/bajada	55 s
Altezza di sollevamento	Lifting height	Hubhöhe	Hauteur de levage	Altura de elevación	1890 mm
Motore	Motor	Motorleistung	Puissance moteur	Motor	4 kW - 3 ph 230-400V/50 Hz-